



Advanced Energy Saving Compressed Air Filters

300 SERIES 20 to 1500 scfm (34 to 2459 nm³/h)



Since 1961, the world has turned to SPX FLOW's Deltech's brand for the quality and service demanded by the most critical of applications. Global leaders of industry require durable components that deliver unquestionable reliability. Our precision engineered components and designs deliver outstanding service life and operational longevity. Invest in our experience and gain annuities that will grow for years.

Based in Charlotte, North Carolina, SPX FLOW is a leading global supplier of highly engineered flow components, process equipment and turn-key systems, along with the related aftermarket parts and services, into the food and beverage, power and energy and industrial end markets. SPX FLOW has more than \$2 billion in annual revenues and approximately 8,000 employees with operations in over 35 countries and sales in over 150 countries around the world. To learn more about SPX FLOW, please visit our website at www.spxflow.com

The Next Generation of Compressed Air Filtration

Energy costs continue to escalate globally, having a negative impact on plant profitability and production costs. Sustainability initiatives in plant operations must be implemented to maintain a competitive advantage.

Air treatment manufacturers are challenged to design equipment that is cost effective, delivers optimum performance and consumes less energy. Deltech's 300 Series Filters are the ideal solution to remove contamination from compressed air systems and save energy.

The 300 Series employs technological advancements in filtration materials and design to ensure premium compressed air quality and low operational costs.

Filters are tested and rated delivering certifiable performance according to ISO 8573.1: 2010 air quality standards.



Sustainable Energy Savings Solutions...

The development of sustainable energy savings compressed air treatment solutions is the driving principle behind Deltech's product designs. The 300 Series provides the perfect balance between high performance filtration and low pressure drop. Patented filter elements (US 7,618,480 B2) maintain low pressure drop and long service life.

By minimizing resistance to flow, energy costs are significantly reduced. The example demonstrates the effect of pressure drop on operating costs.



ANNUALIZED COST OF PRESSURE DROP

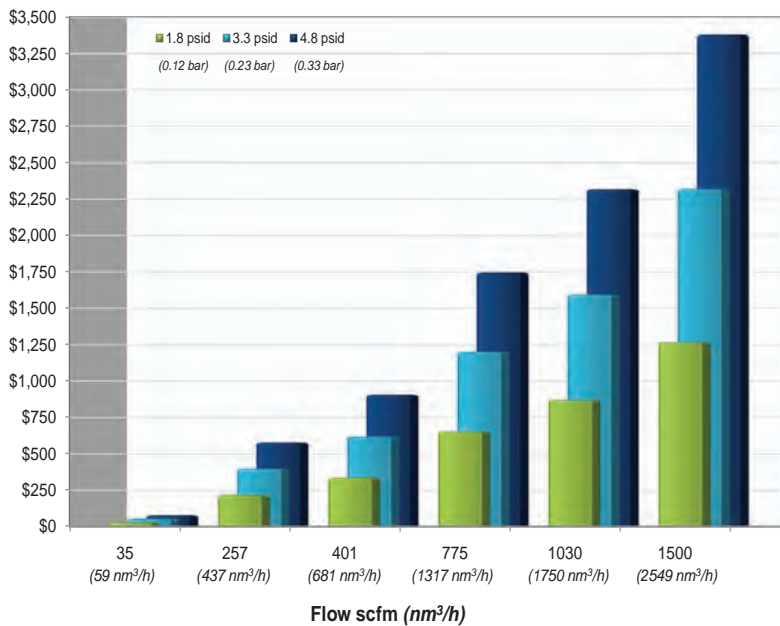

EXAMPLE:

Model: 315-H3 High Performance Coalescing Filter
Flow: 1030 scfm (1750 nm³/h)
Hours of Operation: 8000 hours
Operating Pressure: 101.5 psig (7 bar)
Power Cost: \$0.10/kWh
Pressure Drop: 1.8 psid (0.12 bar)
Cost of Pressure Drop: \$870/yr

Under identical operation conditions, conventional filters maintain a higher cost of ownership.

Conventional Filters:
Pressure Drop: 3.3 psid (0.23 bar)
Cost of Pressure Drop: \$1,596/yr
Pressure Drop: 4.8 psid (0.33 bar)
Cost of Pressure Drop: \$2,321/yr

300 SERIES PRESSURE DROP PERFORMANCE*

Element Grade	Filter Description	Dry Δp		Wetted Δp	
		psig	bar	psig	bar
S3	Bulk Liquid Separator/Filter	0.8	0.06	1.0	0.07
P3	General Purpose Filter	0.6	0.04	1.4	0.10
H3	High Efficiency Oil Removal Filter	0.6	0.04	1.8	0.12
U3	Ultra High Efficiency Oil Removal Filter	0.8	0.06	2.0	0.14
C3	Oil Vapor Removal Filter	1.0	0.07	-	-

*Pressure drop not to exceed stated values at ISO 12500 test conditions

International Standards for Test & Measurement

ISO 12500

ISO 12500 defines a universal method for manufacturers to test and rate compressed air filters. Critical performance parameters are specified for inlet oil challenge and solid particulate size distribution.

- ISO 12500-1 defines the testing of coalescing filters for oil aerosol removal performance.
- ISO 12500-2 quantifies vapor removal capacity of adsorption filters.
- ISO 12500-3 outlines requirements to test particulate filters for solid contaminant removal.

The 300 Series is tested to ISO 12500. Test results provide certifiable performance data based on defined challenge concentrations.



300 SERIES FILTRATION PERFORMANCE

Element Grade	S3	P3	H3	U3	C3
Particle Retention Size¹ <i>(Per ISO 12500-3)</i>	3.0 µm	1.0 µm	0.01 µm	0.01 µm	0.01 µm
Particle Removal Efficiency <i>(Per ISO 12500-3)</i>	-	99.999+%	99.999+%	99.9999+%	99.999+%
Oil Removal Efficiency <i>(Per ISO 12500-1)</i>	50%	80%	99.9+%	99.99+%	-
Remaining Oil Content² <i>(Per ISO 12500-1)</i>	5.0 mg/m ³	2.0 mg/m ³	< 0.01 mg/m ³	< 0.001 mg/m ³	< 0.004 mg/m ³ (as a vapor)

¹ Solid particulate size distribution 0.01 to 5.0 µm

² Inlet oil challenge concentration 10mg/m³

ISO 8573.1:2010 AIR QUALITY STANDARD

ISO 8573, the international standard for compressed air quality, defines the amount of contamination permissible in compressed air.

- The standard identifies three primary forms of contamination in compressed air systems – solid particles, water and oil.
- Contaminants are classified and assigned a quality class, ranging from Class 0, the highest purity level, to Class 9, the most relaxed

ISO Quality Class 8573.1: 2010

Element Grade	ISO Quality Class Solids	ISO Quality Class Oil
S3	3	5
P3	2	4
H3	1	1
U3	1	1
C3	1	1 <i>(as a vapor)</i>



Deltech's 300 Series elements are performance validated to ISO 12500 ensuring air quality delivered is in accordance to ISO 8573.1: 2010 classifications

Air Quality Class	Solid Particles			Water Vapor Pressure		Oil	
	Maximum number of particles per m ³			Dew Point		Total Oil Concentration: Aerosol, Liquid & Vapor	
	0.10 - 0.5 micron	0.5 - 1.0 micron	1.0 - 5.0 micron	°C	°F	mg / m ³	ppm _{w/w}
0	As specified by the equipment user or supplier and more stringent than class 1						
1	≤ 20,000	≤ 400	≤ 10	≤ -70	≤ -94	0.01	0.008
2	≤ 400,000	≤ 6,000	≤ 100	≤ -40	≤ -40	0.1	0.08
3	-	≤ 90,000	≤ 1,000	≤ -20	≤ -4	1	0.8
4	-	-	≤ 10,000	≤ +3	≤ +37	5	4
5	-	-	≤ 100,000	≤ +7	≤ +45	-	-

Patented Venturi-Wave™ Element

① Patented Venturi-Wave™ Element Design

- The venturi profile promotes a turbulent-free transition for compressed air entering the element
- Optimized flow distribution through the element minimizes pressure loss and reduces system operating cost
- Unique backside contour assists smooth movement of air exiting the filter housing

② Deep Bed Pleated, High Performance Media

- Increased effective filtration surface area, reduces pressure drop by 50%
- 96% voids-volume ratio optimizes dirt loading capacity
- HEPA grade micro fiberglass media maximizes efficiency
- Thermally bonded polyester support layers minimize media migration
- Low wetted pressure drop for the life of the element
- Seam welded, stainless steel inner and outer support cores enhance dimensional stability of the element
- Chemically inert, non-aging polyester drain layer expedites removal of liquid
- All materials of construction are silicone free

③ Element Grade Identification

- Color coded end caps promote ease of element grade identification
- Bottom end caps pad printed with genuine Deltech filter element replacement part number



Element - Materials of Construction

Filter Media	HEPA grade borosilicate fiberglass
Inner/Outer Support Cores	400 Series stainless steel
Drainage Layer	Filtration grade polyester
End Caps	Fiberglass reinforced polyamide resin
Bonding Agent	Polyurethane
End Cap Seal	Nitrile

Optimized Housing Design

④ Sculpted Design

- Covers flow ranges 20 scfm to 1500 scfm (34 to 2549 nm³/h)
- Flanged inlet and outlet connections make installation easy
- Fourteen flow models, with multiple port sizes, 1/4" to 3" NPT, allow for greater application flexibility
- Sculpted housing designs, with large unrestricted flow paths, reduce pressure drop

⑤ Safety Built-In

- Die cast aluminium housings provide a cost effective solution in the 1030 to 1500 scfm (1750 to 2549 nm³/h) flow range
- Chromated housings, with a polyester epoxy powder coating for corrosion resistance
- Internally ribbed bowls facilitate condensate draining
- Audible alarm when attempting bowl removal under pressure

Housing - Materials of Construction

Filter Head	Aluminum
Filter Housing	Aluminum
Seals	Nitrile
Chromating Process	Hexavalent-free trivalent
Exterior Coating	Polyester epoxy powder
Manual Drain	Brass body, Viton [®] seal
Internal Float Drain	Polyacetal float, Brass body, Viton [®] seal and stainless steel springs











Total system protection

The 300 Series provides protection for the entire compressed air system. A wide range of filters exceeds customer requirements for ISO Quality Class performance, service life and optimal energy savings.

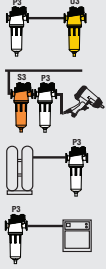
Compressed air contamination exists in three states- solid, liquid and gaseous.

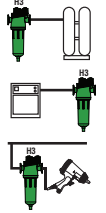
- Ingested contaminants appear in the form of water, hydrocarbons and particulates.
- The compression process introduces lubricant and wear particles into the system.
- Piping distribution and storage tanks foster contaminants in the form of rust, pipe scale and bacteria.

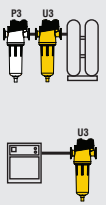
300 SERIES ELEMENT SPECIFICATIONS

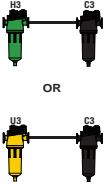
Element Grade	Description	ISO Performance Data	Where Applied
	Grade S3 Bulk Liquid Separator/Filter Separator/filter removes bulk liquid and solids.	<ul style="list-style-type: none"> ▪ Removes solids 3 micron and larger ▪ Remaining oil content 5 mg/m³ ISO 8573.1: 2010 Air Quality Class: <ul style="list-style-type: none"> ▪ Solid Particles - Class 3 ▪ Remaining Oil Content - Class 5 	<p>Downstream of aftercoolers</p> <p>At point-of-use if no aftercooler/ separator used upstream</p> 
	Grade P3 General Purpose Filter General purpose filtration to protect pneumatically operated tools, motors and cylinders.	<ul style="list-style-type: none"> ▪ Removes solids 1.0 micron and larger ▪ Remaining oil content 2.0 mg/m³ ISO 8573.1: 2010 Air Quality Class: <ul style="list-style-type: none"> ▪ Solid Particles - Class 2 ▪ Remaining Oil Content - Class 4 	<p>Upstream of ultra high efficiency oil removal filters</p> <p>At point-of-use if aftercooler/ separator installed upstream</p> <p>Downstream of heatless desiccant dryers</p> <p>Upstream of refrigerated dryers</p> 
	Grade H3 High Efficiency Oil Removal Filter Fine coalescer provides oil free air for industrial applications such as spray painting, injection molding, instrumentation and control valves.	<ul style="list-style-type: none"> ▪ Removes 99,999+% of solids 0.01 micron and larger ▪ Remaining oil content < 0.01 mg/m³ ISO 8573.1: 2010 Air Quality Class: <ul style="list-style-type: none"> ▪ Solid Particles - Class 1 ▪ Remaining Oil Content - Class 1 	<p>Upstream of desiccant dryers</p> <p>Downstream of refrigerated dryers</p> <p>At point-of-use if aftercooler/ separator installed upstream</p> 
	Grade U3 Ultra High Efficiency Oil Removal Filter Ultra fine coalescer delivers oil free air for critical applications including, conveying, electronics manufacturing and nitrogen replacement.	<ul style="list-style-type: none"> ▪ Removes 99,999+% of solids 0.01 micron and larger ▪ Remaining oil content < 0.001 mg/m³ ISO 8573.1: 2010 Air Quality Class: <ul style="list-style-type: none"> ▪ Solid Particles - Class 1 ▪ Remaining Oil content - Class 1 	<p>Upstream of desiccant dryers</p> <p>Upstream of membrane dryers (Use a P3 Grade as a prefilter if heavy liquid loads are present)</p> <p>Downstream of refrigerated dryers</p> 
	Grade C3 Oil Vapor Removal Filter Activated carbon filter removes oil vapor and provides oil free air for food and drug manufacturing, breathing air and gas processing.	<ul style="list-style-type: none"> ▪ Removes solids 0.01 micron and larger ▪ Remaining oil content < 0.004 mg/m³ (as a vapor) ISO 8573.1: 2010 Air Quality Class: <ul style="list-style-type: none"> ▪ Solid Particles - Class 1 ▪ Remaining Oil Content - Class 1 	<p>Downstream of high efficiency oil removal filters</p> 

Accessories & Options

The 300 Series is supported by a complete line of accessories and options making filter installation and differential pressure monitoring easy.

Installation Flexibility



Filter Connector Clamps

Stainless steel clamps easily connects filters in series

Optional (02-17)

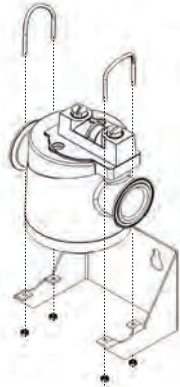

Wall Mount Bracket

Rugged design provides installation flexibility

Optional (02-17)

Pressure Monitoring

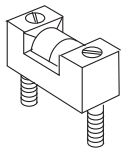

P1

Differential Pressure Slide Indicator

Color indicator moves based on differential pressure

Standard S3, P3, U3, H3 Grades (02-17)

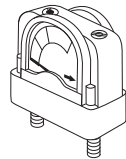

G1

Differential Pressure Gauge

Two color gauge face indicates element change-out based on differential pressure

Standard S3, P3, U3, H3 Grades (02-17)

Condensate Management



T

Manual Drain

Condensate may be drained manually through clockwise adjustment

Standard C3 Grade (02-12)
Optional S3, P3, U3, H3 Grades (02-12)

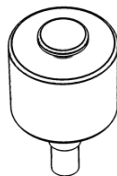

D

No Air Loss Internal Float Drain

Effectively removes condensate without loss of air

Standard S3, P3, U3, H3 Grades (02-12)
Optional C3 Grade (02-12)

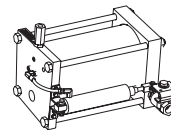

W

No Loss Drain

Reliably removes condensate without need for electricity

Optional (02-17)

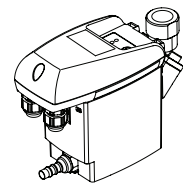

Z1

Z2

No Air Loss Electric Demand Drain

Efficiently removes condensate based on demand

Optional (02-17)

300 Series Filter Model Number Configuration



Housing-Connection-Flow

Model*	Connection		Flow @ 101.5 psig scfm	Flow @ 7 bar nm ³ /h
	in	mm		
02	1/4"	6.4	20	34
03	3/8"	9.5	35	59
04	1/2"	12.7	50	85
06	3/4"	19.1	75	127
07	3/4"	19.1	103	175
08	1.0"	25.4	157	267
10	1 1/2"	38.1	257	437
11	1 1/2"	38.1	360	612
12	2"	50.8	401	681
13	2 1/2"	63.5	584	992
14	2 1/2"	63.5	775	1317
15	2 1/2"	63.5	1030	1750
16	3"	76.2	1200	2039
17	3"	76.2	1500	2549

*BSP threads are available. Add B to the model number. Example 302B-S3-DP1

Element Grade

S3	Bulk Liquid Removal
P3	Particulate Removal
H3	Oil Removal
U3	High Efficiency Oil Removal
C3	Oil Vapor Removal

Options

T	Manual Drain
D	Internal Automatic Drain
P1	Differential Pressure Slide Indicator
G1	Differential Pressure Gauge
X	External Drain Adaptor (02-12)
Z1	Electric Demand Drain (02-12)
Z2	Electric Demand Drain (13-17)
W	External No Loss Drain (13-17)

Example: 300-S3-DP1

Flow and Connection: 20 scfm (34 nm³/h); 1/4" NPT

Element Grade: S3- bulk liquid removal

Options: Internal automatic drain; differential pressure slide indicator

CAPACITY CORRECTION FACTORS

300 Series flow capacities are rated per ISO 12500 conditions @ 101.5 psig (7 bar). To size the filter for non-standard conditions, a correction factor must be applied. Table 1 provides correction factors for inlet air pressure.

Do not select filters by pipe size; use flow rate and operating pressure.

Table 1 - Correction Factors for Inlet Pressure

Inlet Pressure	psi	20	30	40	60	80	100	120	150	200	250	300
		bar	1.4	2.1	2.8	4.2	5.6	6.9	8.4	10.6	14.1	17.6
Correction Factor		0.30	0.39	0.48	0.65	0.82	1.00	1.17	1.43	1.87	2.31	2.74

Adjusted Flow Capacity

To calculate the flow capacity based on non-standard inlet conditions, multiply the filter's rated flow capacity by the corresponding inlet pressure correction factor.

High Efficiency Coalescing Filter: 304-H3-DP

Rated capacity: 50 scfm (85 nm³/h)

Operating Conditions: 120 psig (8.3 bar)

Adjusted Flow Capacity: 50 scfm x 1.17 = 59 scfm (100 nm³/h)

Technical Specifications

Drain Option	Maximum Operating Pressure	Maximum Operating Temperature	Minimum Operating Temperature
Drain Plug	250 (17.2 barg)	150°F (66°C)	35°F (2°C)
Internal Float	250 (17.2 barg)	150°F (66°C)	35°F (2°C)
Electric Demand	232 (15.9 barg)	140°F (60°C)	35°F (2°C)
Externally Mounted Mechanical	150 (10.3 barg)	120°F (49°C)	35°F (2°C)

C3 Grade: Recommended maximum inlet air temperature not to exceed 100°F to maintain 1,000 hours of life

300 Series Specifications

Model Number	Max. Flow @ 101.5 psig (7 bar)		Connections NPT	Dimensions								Weight	
	scfm	nm ³ /h		"A"		"B"		"C"		"D"		lbs	kg
				in	mm	in	mm	in	mm	in	mm		
302	20	34	1/4"	4.5	114	8.1	206	6.8	173	4	102	1.8	0.8
303	35	59	3/8"	4.5	114	8.1	206	6.8	173	4	102	1.8	0.8
304	50	85	1/2"	4.5	114	9.9	251	8.5	216	4	102	1.9	0.9
306	75	127	3/4"	5.2	132	10.3	262	8.7	221	5	127	3.1	1.4
307	103	175	3/4"	5.2	132	10.3	262	8.7	221	5	127	3.1	1.4
308	157	267	1.0"	5.2	132	12.8	325	11.7	297	5	127	3.5	1.6
310	257	437	1 1/2"	7.9	201	13.3	338	10.9	277	7	178	8.4	3.8
311	360	612	1 1/2"	7.9	201	17.1	434	14.7	373	7	178	9.9	4.5
312	401	681	2"	7.9	201	22.3	566	19.9	505	7	178	11.6	5.3
313	584	992	2 1/2"	9.1	231	24.9	632	21.7	551	8	203	18.6	8.5
314	775	1317	2 1/2"	9.1	231	24.9	632	21.7	551	8	203	18.6	8.5
315	1030	2039	2 1/2"	9.1	231	32.2	818	28.9	734	8	203	27.7	12.6
316	1200	2039	3"	9.1	231	32.2	818	28.9	734	8	203	27.7	12.6
317	1500	2549	3"	9.1	231	42.7	1085	39.4	1001	8	203	41.3	18.8

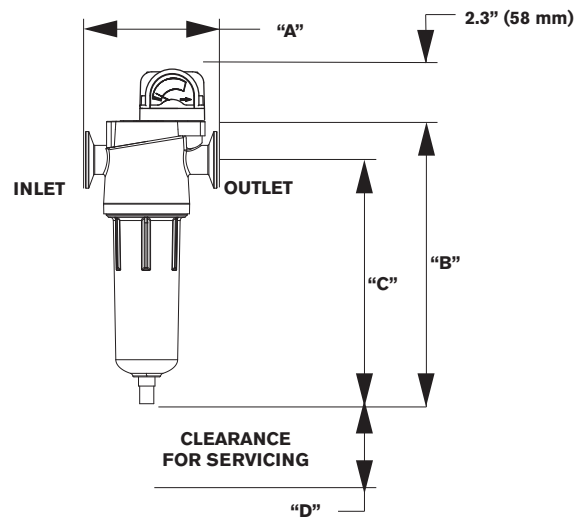
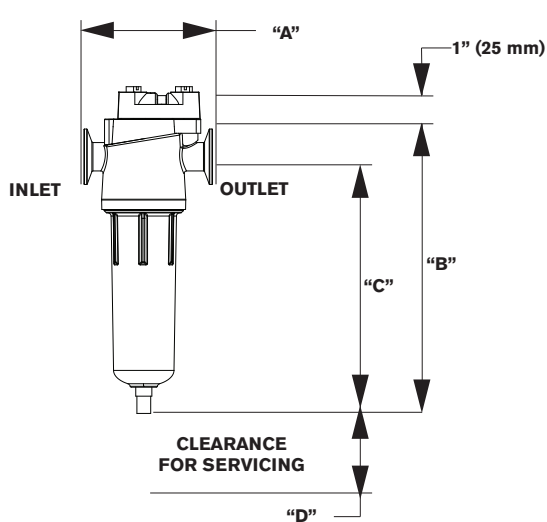



Global locations

USA

SPX FLOW

4647 SW 40th Avenue
Ocala, Florida 34474-5788
United States of America
P: (724) 745-1555
E: deltech.americas@spxflow.com

CANADA

SPX FLOW

1415 California Avenue
Brockville, ON, k6v 7h7
Canada
P: (800) 267-3884
E: salescanada@spxflow.com

EMEA

SPX FLOW MOERS GMBH

Konrad-Zuse-Straße 25
D-47445 Moers, Germany
P: +49 (0) 28 41 / 819-0
F: +49 (0) 28 41 / 87112
E: csc@spxflow.com

SPX FLOW INC.

4647 SW 40th Avenue
Ocala, Florida 34474-5788 U.S.A.
P: (724) 745-1555
F: (724) 745-6040
E: deltech.americas@spxflow.com
www.spxflow.com/deltech

SPX FLOW, Inc. reserves the right to incorporate our latest design and material changes without notice or obligation.

Design features, materials of construction and dimensional data, as described in this bulletin, are provided for your information only and should not be relied upon unless confirmed in writing. Please contact your local sales representative for product availability in your region. For more information visit www.spxflow.com.

The green "X" and "X" are trademarks of SPX FLOW, Inc.